





















 BLANC  BLEU PROFOND

 MOTEUR CENTRAL YAMAHA
PW-C2 55 NM

 500 WH
Autonomie max.
110 KM



CARACTÉRISTIQUES TECHNIQUES

- | | |
|--|--|
|  Moteur
YAMAHA PW-C2 - 250 W - 55 NM |  Guidon
CINTRE : ERGONOMIQUE
POIGNÉES : ERGONOMIQUES BI-MATIÈRE |
|  Batterie
MATRA - 500 WH |  Jantes
S : 24" / M, L : 26" - MACH 1 ALUMINIUM - 36 RAYONS |
|  Temps de charge / Autonomie*
100 % : 5H30 / 50>110 KM |  Pneus
CST, S : 24 X 2.1 / M, L : 26 X 1.85 |
|  Display
YAMAHA DÉPORTÉ TYPE A, LED |  Selle
SELLE ROYAL ENSENZA RELAXED |
|  Assistance
4 MODES D'ASSISTANCE + MODE AUTOMATIQUE + MODE PIÉTON |  Tige de selle
SUSPENDUE |
|  Cadre
ALUMINIUM |  Éclairage
TRELOCK LED AVANT ET ARRIÈRE |
|  Fourche
SUSPENDUE 45 MM |  Accessoires
BÉQUILLE / PORTE-BAGAGE / GARDE-BOUES ALUMINIUM |
|  Transmission / vitesses
SHIMANO ALTUS / 8 VITESSES |  Tailles
S : 36 CM - 24" / M : 44 CM - 26" / L : 48 CM - 26" |
|  Freins
À DISQUE HYDRAULIQUES SHIMANO |  Garantie
CADRE 10 ANS, MOTEUR ET BATTERIE 2 ANS |
|  Potence
RÉGLABLE NOIRE | |

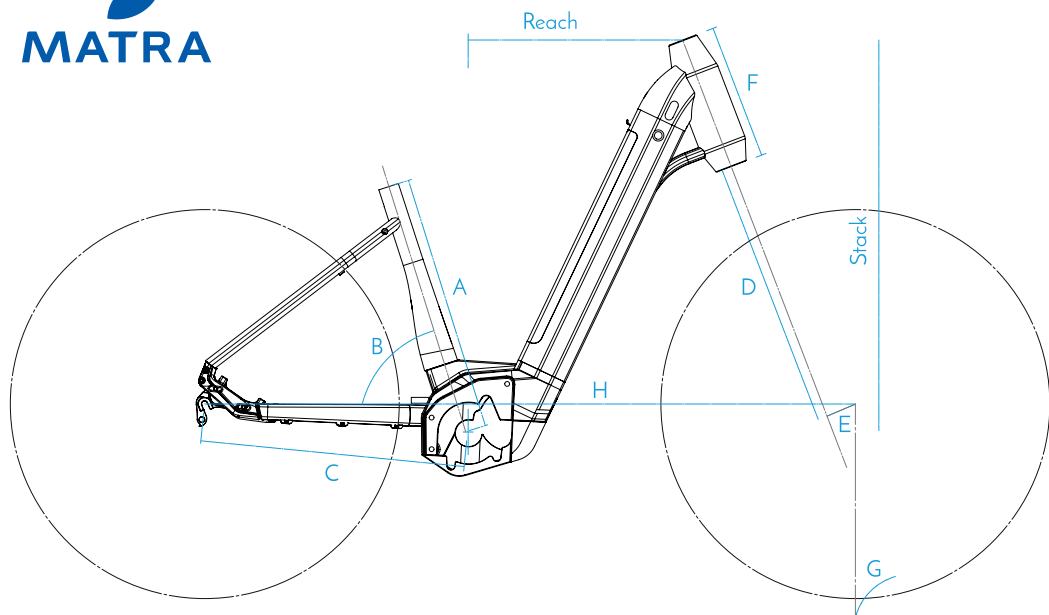

Taille	S	M	L
Taille cycliste	1m60 - 1m73	1m72 - 1m85	1m84 - 1m95
Reach : Distance horizontale pédalier > guidon	350mm	363mm	400mm
Stack : Élévation pédalier > guidon	635mm	667mm	670mm
Diamètre de roue	24"	26"	26"
Suspension avant	48mm		
A - Longueur du tube de selle	533mm	580mm	606mm
B - Angle du tube de selle	69°		
C - Longueur des bases	420mm	450mm	
D - Longueur de fourche	411mm	443mm	
E - Déport de la fourche	41mm	43,5mm	
F - Longueur douille de direction	125mm	135mm	145mm
G - Angle de chasse	72°		
H - Empattement	1045mm	1095mm	1130mm