



I-FORCE PLAY MAX

Prix public conseillé

3 699 € TTC



● NOIR





 MOTEUR CENTRAL YAMAHA
PW-S2 75 NM

 500 WH
Autonomie max.
90 KM



CARACTÉRISTIQUES TECHNIQUES

-  Moteur
YAMAHA PW-S2 - 250 W - 75 NM
-  Batterie
MATRA - 500 WH
-  Temps de charge / Autonomie*
100 % : 7H00 / 40>90 KM
-  Display
YAMAHA DÉPORTÉ TYPE A, LCD
-  Assistance
5 MODES D'ASSISTANCE + MODE PIÉTON
-  Cadre
ALUMINIUM
-  Fourche
RIGIDE ALUMINIUM
-  Transmission / vitesses
SHIMANO DEORE / 11 VITESSES
-  Freins
SHIMANO 4 PISTONS, HYDRAULIQUE À DISQUE
-  Potence
ALUMINIUM 50 MM

-  Guidon
CINTRE : DROIT 740 MM
-  Jantes
26" - ALUMINIUM
-  Pneus
KENDA 26 X 4.0
-  Selle
SELLE ITALIA X3
-  Tige de selle
ALUMINIUM
-  Éclairage
A PILE AVANT ET ARRIÈRE
-  Tailles
M : 45 CM - 26"
-  Garantie
CADRE 10 ANS, MOTEUR ET BATTERIE 2 ANS

* Les autonomies sont indiquées à titre indicatif. Elles sont mesurées selon un protocole de tests défini par Easybike Group ou communiquées par le fabricant de batteries. Les facteurs de perte d'autonomie principaux sont : vent contraire, dénivelés positifs, température inférieure à 15°C, pneus sous-gonflés, poids de l'utilisateur supérieur au poids nominal défini pour nos tests (70 kg), mauvais réglages du vélo, mauvaise utilisation des vitesses.

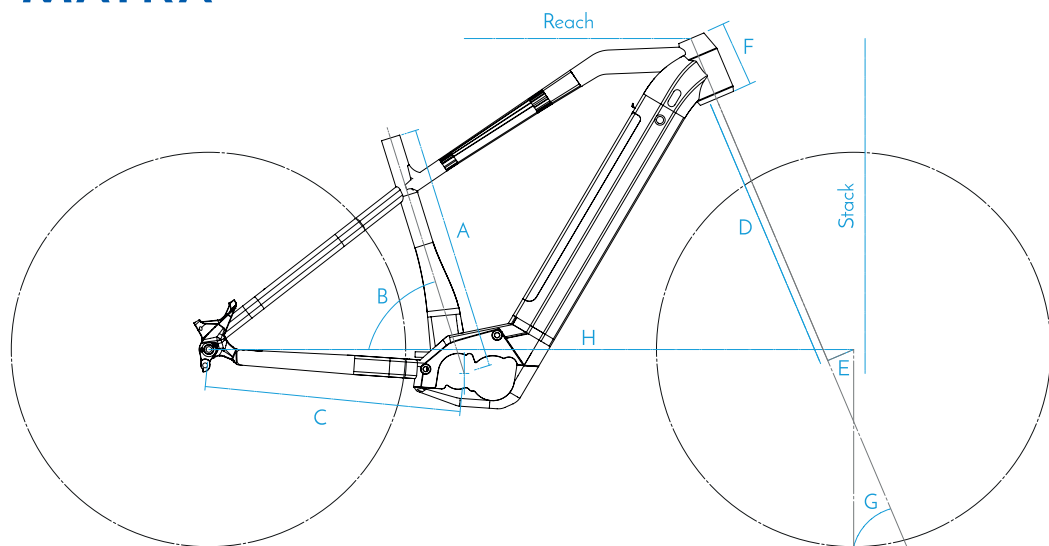

Taille	S	M	L
Taille cycliste	1m60 - 1m73	1m72 - 1m85	1m84 - 1m95
Reach : Distance horizontale pédalier > guidon	410mm	430mm	450mm
Stack : Élévation pédalier > guidon	610mm	616mm	620mm
Diamètre de roue	27.5"	27.5"	27.5"
Suspension avant	120mm		
A - Longueur du tube de selle	430mm	450mm	470mm
B - Angle du tube de selle	74°		
C - Longueur des bases	460mm		
D - Longueur de fourche	516.5mm		
E - Déport de la fourche	46mm		
F - Longueur douille de direction	115mm	120mm	125mm
G - Angle de chasse	67°		
H - Empattement	1160mm	1180mm	1200mm