





















● BLEU ● ANTHRACITE

 MOTEUR CENTRAL YAMAHA
PW-S2 75 NM

 630 WH
Autonomie max.
150 KM

 YAMAHA

CARACTÉRISTIQUES TECHNIQUES

- | | |
|--|--|
|  Moteur
YAMAHA PW-S2 - 250 W - 75 NM |  Guidon
CINTRE : ERGONOMIQUE
POIGNÉES : ERGONOMIQUES BI-MATIÈRE |
|  Batterie
MATRA - 630 WH |  Jantes
28" - MACH 1 - 32 RAYONS |
|  Temps de charge / Autonomie*
100 % : 7H00 / 70>150 KM |  Pneus
CST 700X42C |
|  Display
YAMAHA DÉPORTÉ TYPE A, LED |  Selle
SELLE ROYAL ENSENZA |
|  Assistance
4 MODES D'ASSISTANCE + MODE AUTOMATIQUE + MODE PIÉTON |  Tige de selle
SUSPENDUE |
|  Cadre
ALUMINIUM |  Éclairage
TRELOCK LED AVANT ET ARRIÈRE |
|  Fourche
SUNTOUR SUSPENDUE 55 MM |  Accessoires
BÉQUILLE / PORTE-BAGAGE / GARDE-BOUES ALUMINIUM /
ANTIVOL DE CADRE |
|  Transmission / vitesses
SHIMANO DEORE / 10 VITESSES |  Tailles
S : 36 CM - 28" / M : 44 CM - 28" / L : 48 CM - 28" |
|  Freins
À DISQUE HYDRAULIQUES SHIMANO |  Garantie
CADRE 10 ANS, MOTEUR ET BATTERIE 2 ANS |
|  Potence
ALUMINIUM AJUSTABLE | |

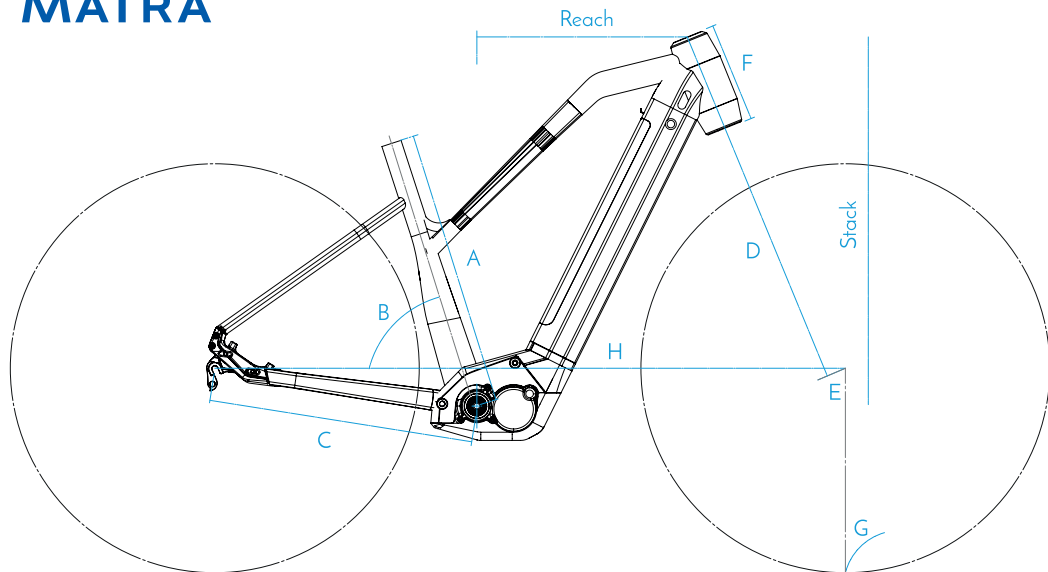

Taille	S	M	L
Taille cycliste	1m60 - 1m73	1m72 - 1m85	1m84 - 1m95
Reach : Distance horizontale pédalier > guidon	350mm	370mm	390mm
Stack : Élévation pédalier > guidon	635mm	637mm	642mm
Diamètre de roue	28"	28"	28"
Suspension avant	63mm		
A - Longueur du tube de selle	430mm	480mm	530mm
B - Angle du tube de selle	64,5°		
C - Longueur des bases	460mm		
D - Longueur de fourche	459mm		
E - Déport de la fourche	43,5mm		
F - Longueur douille de direction	125mm	135mm	145mm
G - Angle de chasse	68°		
H - Empattement	1090mm	1100mm	1120mm